

Data Sheet



Article number: 20887473

Description: E+G Control handwheel
GN 736-62-K10-D

Measures

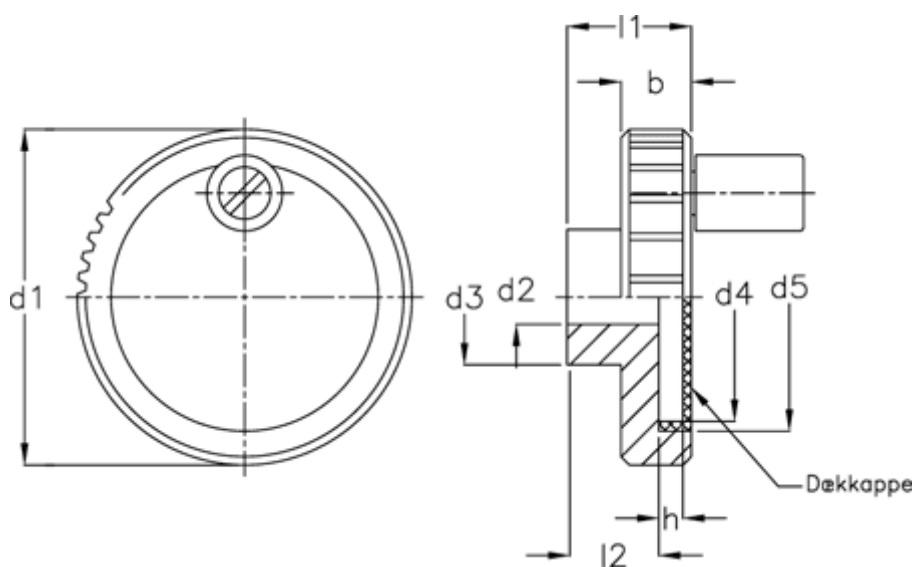

b -0.5	= 13	Handle	= 14
d1	= 62	l1	= 23
d2 H8 without slot	= B 10	l2	= 17
d2 H8 with slot	= K 10		
d3	= 25		
d4	= 47		
d5	= 49.5		
h	= 3.8		